

型号

EFD-3550-1

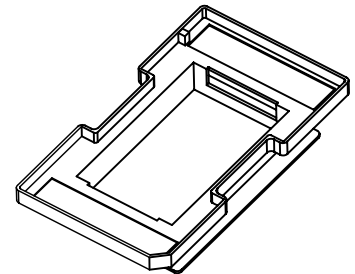
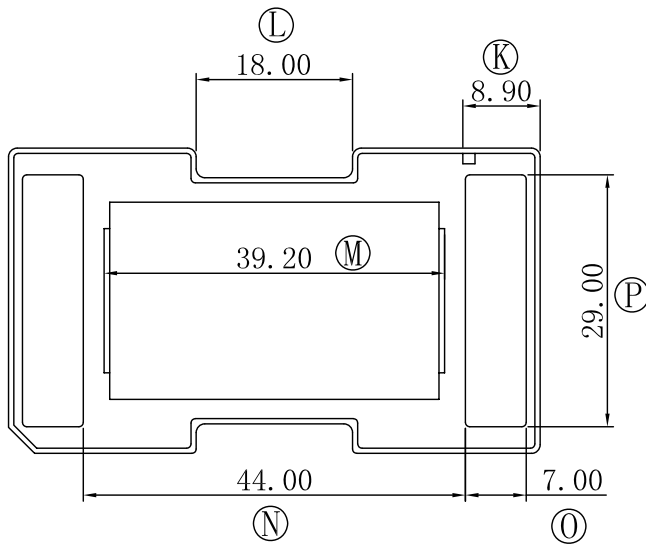
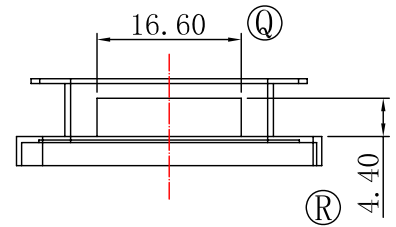
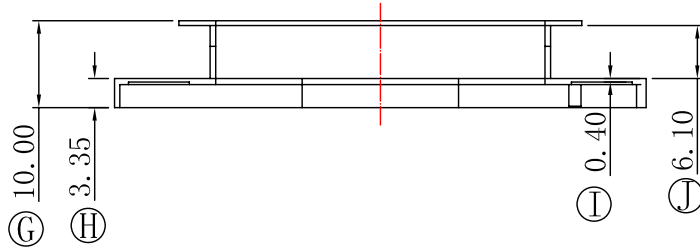
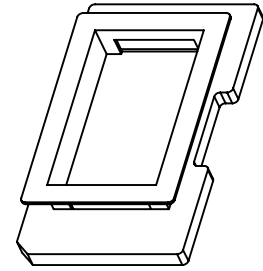
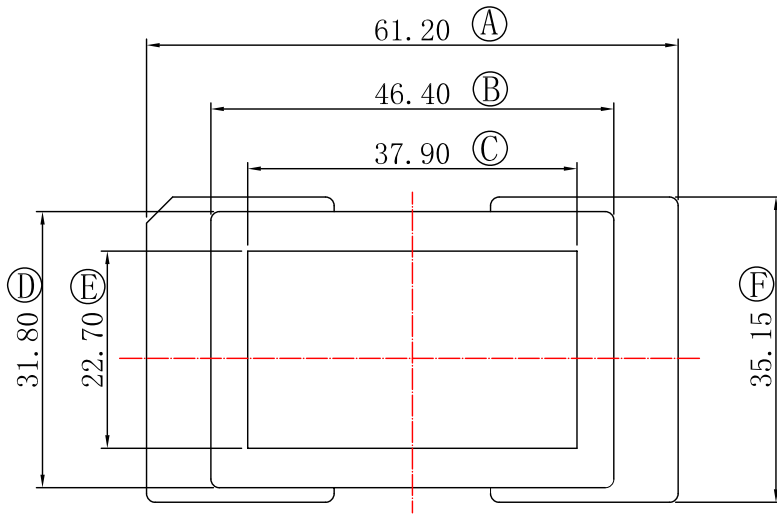

REV	DATE	REVISIONS REC

深圳市捷达成电子有限公司

SHENZHEN JIE DA CHENG ELECTRONICS CO.,LTD.

TEL:0755-27317730 FAX:0755-27317731

ANGLE:  
+/-1°

MODEL NAME:  
EFD-3550-1 COVER

UNIT:  
MM

UL REC:  
UL 94V-0

BOBBIN MATERIAL:  
LCP

DRAFTER L.R.J

TOLERANCE

SCALE:  
4/1

PIN TENSION LOAD:

PIN MATERIAL:

0<L<4 ±0.1

4<L<16 ±0.2

16<L<50 ±0.3

PIN PITCH ±0.2

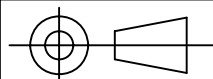

DATE:  
2012-06-25

DRAWING NO:  
EFD-3550-1

REV:  
1.0