

型号

ER-4201

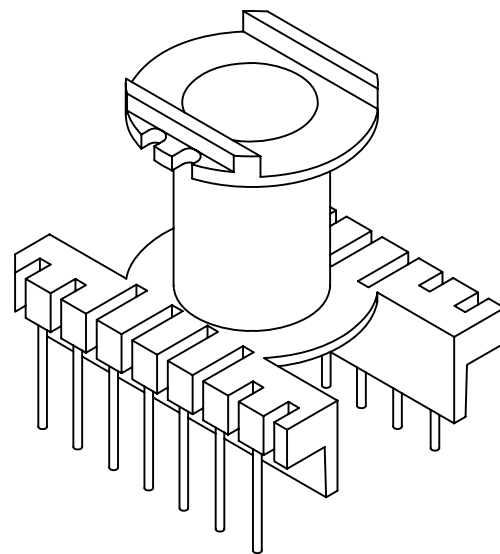
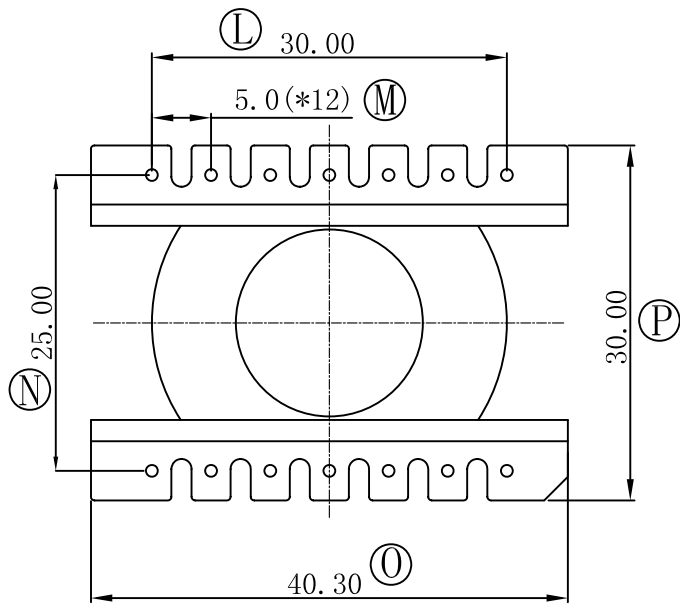
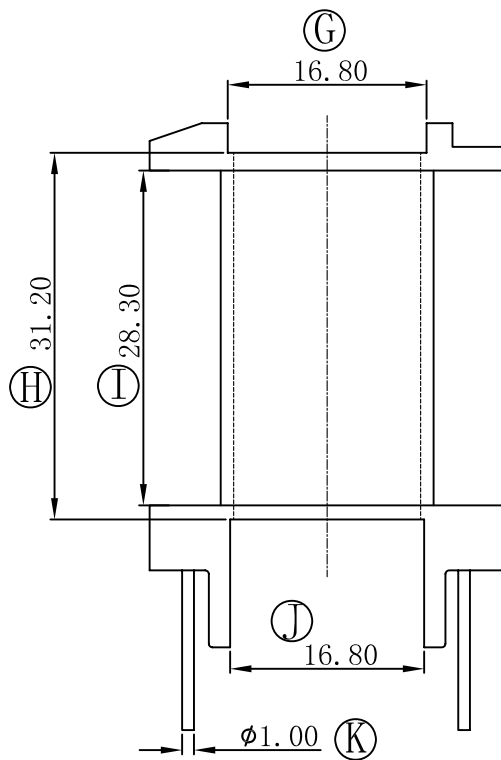
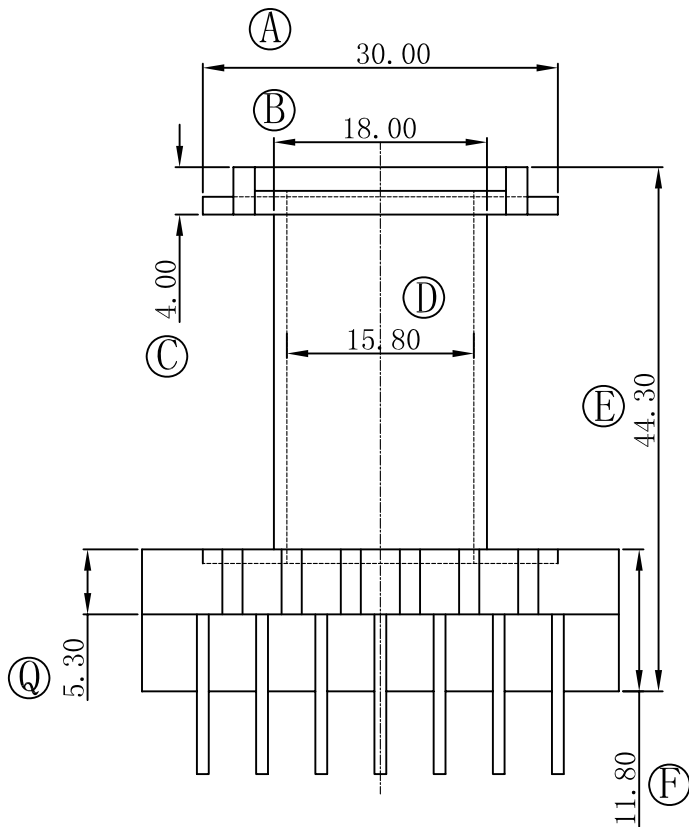

REV	DATE	REVISIONS REC

深圳市捷达成电子有限公司

SHENZHEN JIE DA CHENG ELECTRONICS CO.,LTD.

TEL:0755-27317730 FAX:0755-27317731

ANGLE:
+/-1°

UNIT:
MM

SCALE:
4/1

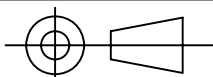

MODEL NAME:
ER-4201 7+7PIN

UL REC:
UL 94V-0

PIN TENSION LOAD:
1.0KG MIN

DATE:
2012-06-18

BOBBIN MATERIAL:
PHENOLIC

PIN MATERIAL:
CP WIRE

DRAWING NO:
ER-4201

REV:
1.0

DRAFTER

L.R.J

CHECKER

Y.F.

TOLERANCE

0<L<4 ±0.1

4<L<16 ±0.2

16<L<50 ±0.3

PIN PITCH ±0.2