

型号

ER-3512

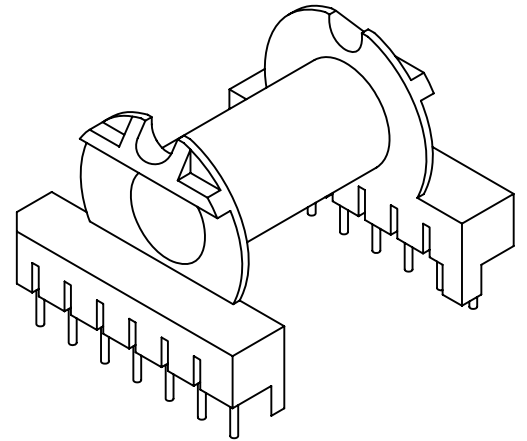
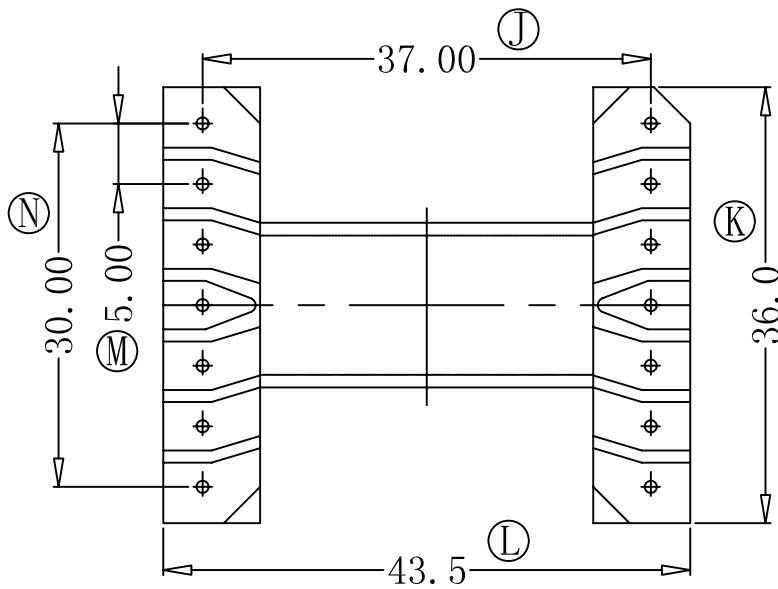
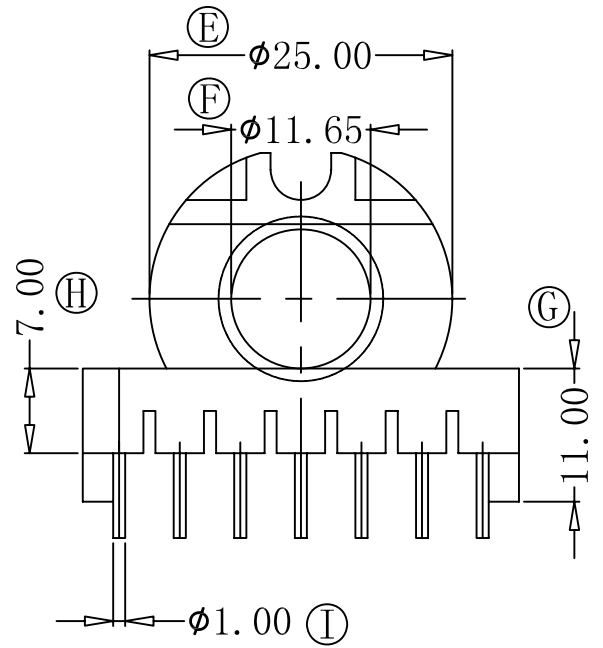
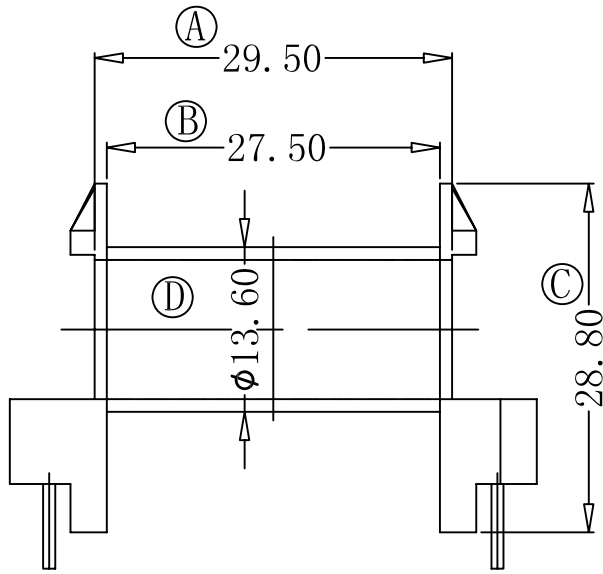

REV	DATE	REVISIONS REC

深圳市捷达成电子有限公司

SHENZHEN JIE DA CHENG ELECTRONICS CO.,LTD.

TEL:0755-27317730 FAX:0755-27317731

ANGLE:  
+/-1°

UNIT:  
MM

SCALE:  
4/1

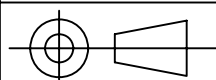

MODEL NAME:  
ER-3512 7+7PIN

UL REC:  
UL 94V-0

PIN TENSION LOAD:  
1.0KG MIN

DATE:  
2008-09-12

BOBBIN MATERIAL:  
PHENOLIC

PIN MATERIAL:  
CP WIRE

DRAWING NO:  
ER-3512

REV:  
1.0

DRAFTER L.R.J

CHECKER Y.F.

TOLERANCE  
 0<L<4 ±0.1  
 4<L<16 ±0.2  
 16<L<50 ±0.3  
 PIN PITCH ±0.2