

型号

EE-1648

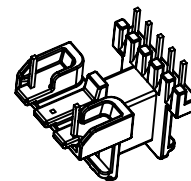
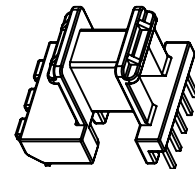
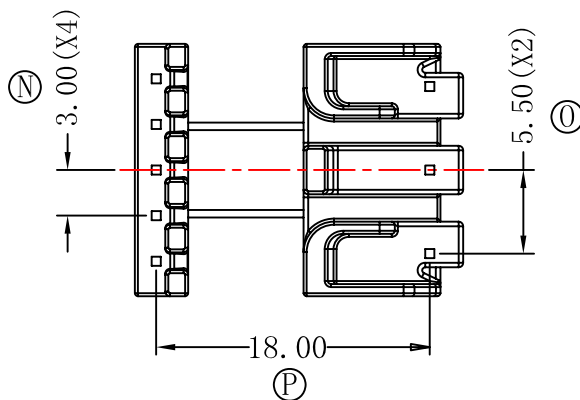
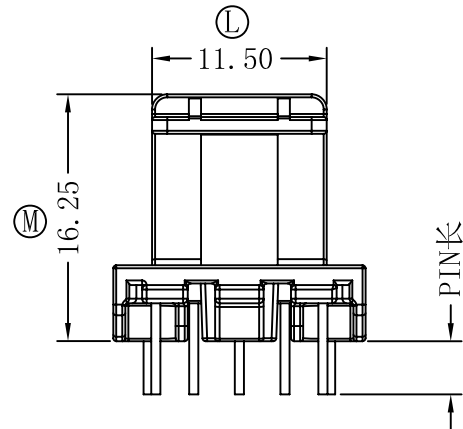
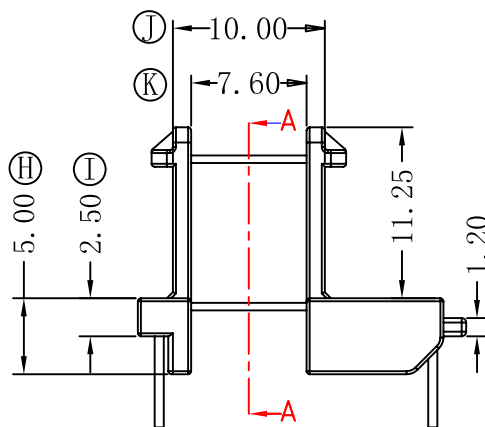
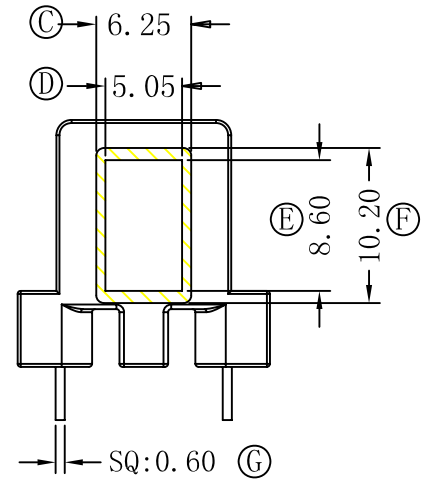
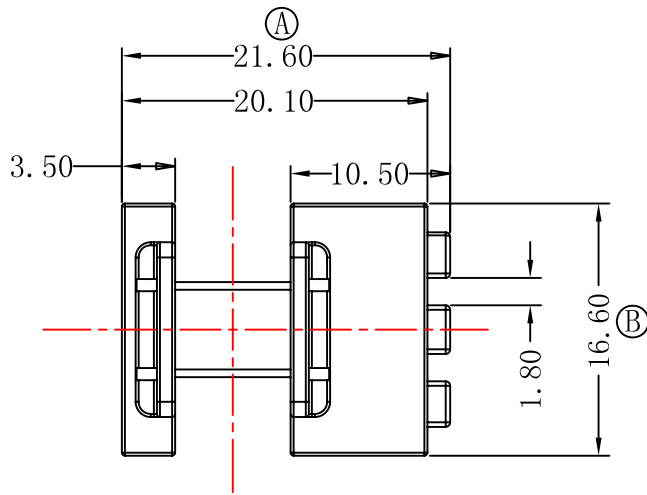

REV	DATE	REVISIONS REC

深圳市捷达成电子有限公司

SHANZHEN JIE DA CHENG ELECTRONICS CO., LTD.
TEL:0755-27317730 FAX:0755-27317731

ANGLE:
+/-1°

MODEL NAME:
EE-1648 5+3PIN

UNIT:
MM

UL REC: UL 94V-0
BOBBIN MATERIAL: PM-9820

SCALE:
4/1

PIN TENSION LOAD: 1.0KG MIN
PIN MATERIAL: CP WIRE

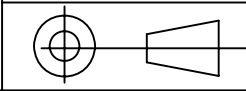

DATE: 2016-1-5
DRAWING NO: EE-1648
REV: 1.0

DRAFTER L.R.J

TOLERANCE	
0<L<4	±0.1
4<L<16	±0.2
16<L<50	±0.3
PIN PITCH	±0.2

CHECKER Y.F.