

型号

ETD-4902

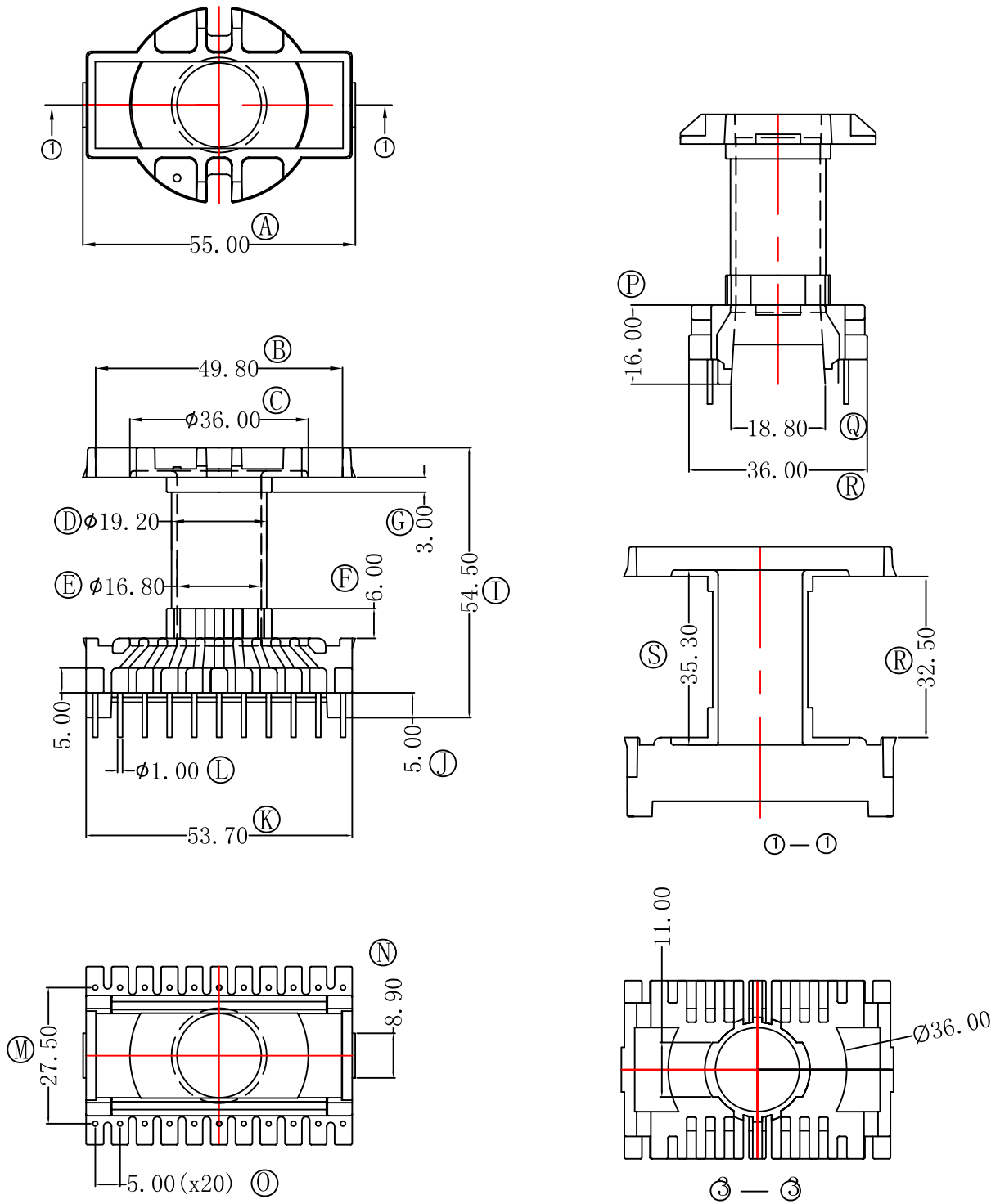

REV	DATE	REVISIONS REC

深圳市捷达成电子有限公司

SHENZHEN JIE DA CHENG ELECTRONICS CO.,LTD.

TEL:0755-27317730 FAX:0755-27317731

ANGLE:  
+/-1°

MODEL NAME:  
ETD-4902 11+11PIN

UNIT:  
MM

UL REC:  
UL 94V-0

BOBBIN MATERIAL:  
PHENOLIC

DRAFTER L.R.J

TOLERANCE

SCALE:  
4/1

PIN TENSION LOAD:  
1.0KG MIN

PIN MATERIAL:  
CP WIRE

CHECKER Y.F.

0<L<4 ±0.1  
4<L<16 ±0.2  
16<L<50 ±0.3  
PIN PITCH ±0.2

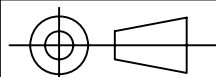

DATE:  
2009-03-13

DRAWING NO:  
ETD-4902

REV:  
1.0